

CAT® ATTACHMENTS

SKID STEER LOADERS
COMPACT TRACK LOADERS



CAT® ATTACHMENTS

SKID STEER LOADERS AND COMPACT TRACK LOADERS



INDEX

AUGERS	4
DRIVE ASSEMBLIES	4
DRIVES	4
BRACKET	4
AUGER BITS	5
STANDARD DUTY	5
INDUSTRIAL	5
INDUSTRIAL ROCK	5
TREE	6
ROCK HEAD	6
MESH GUARD	6
REPLACEMENT PARTS	6
BACKHOE	7
MOUNTING GROUP	7
3 TON BACKHOE ATTACHMENTS	7
RIPPER	7
THUMB	7
COUPLER	7
AUGER DRIVES – BH130	8
AUGER ADAPTERS/EXTENSIONS	8
BUCKETS, DITCH CLEANING – BH130	9
BUCKETS, HEAVY DUTY – BH130	9
BUCKETS, CEMETERY – BH130	9
COMPACTION WHEELS – BH130	10
VIBRATORY PLATE COMPACTOR – BH130	11
BALE GRABS	12
BALE SPEARS	13
BLADES, ANGLE	14
SNOW AND IMPACT KIT	14
BLADES, DOZER	14
SMART GRADING KIT	14
BLADES, BOX	15
BLADES, GRADER	15
BLADE KITS	15
BROOMS, ANGLE	16
BRISTLES	16
KITS	16
BROOMS, PICKUP	17
BRISTLES	17
KITS/BRACKETS	17

INDEX

BROOMS, UTILITY	18	HAMMERS	34
KITS/OPTIONS	18	TOOLS	35
WATER TANK KITS	19	BRACKETS/LINES	36
BRUSHCUTTERS, INDUSTRIAL	19	LEGACY BRACKETS/MOUNTING GROUPS/LINES	37
BRUSHCUTTERS	20	MATERIAL HANDLING ARM	37
BUCKETS	21	MULCHERS	38
CONCRETE SLAB	21	TEETH	39
GENERAL PURPOSE	21	RAKES	40
INDUSTRIAL PERFORMANCE	21	INDUSTRIAL GRAPPLE RAKES	40
LIGHT MATERIAL	22	LANDSCAPE RAKES	40
LOW PROFILE	22	POWER BOX RAKES	40
MATERIAL HANDLING	22	SHEAR	41
MULTI PURPOSE	22	SILAGE DEFACERS	42
SKELETON	23	STUMP GRINDERS	42
INDUSTRIAL GRAPPLE	23	SNOW PRODUCTS	43
UTILITY	23	SNOW BLOWERS	43
UTILITY GRAPPLE KIT	23	SNOW PERFORMANCE KIT	43
UTILITY GRAPPLE	23	SNOW PLOWS	44
BUCKET EDGES	24	SNOW PLOWS, MULTI-V	45
BUCKET HARDWARE	24	SNOW WINGS	45
BUCKET TOOTH BARS	25	STRAIGHT SNOW PUSHES	46
BUCKET BOLT-ON TEETH	25	BACK DRAG EDGES	47
MIXING	26	TILLERS, LANDSCAPE	48
SIDE DISCHARGE	26	TRENCHERS	49
COLD PLANERS	27	CHAINS	50
WATER TANK KITS	28	CRUMBER ARMS/SHOES	51
WATER SPRAY KITS	28	WHEEL SAWS	52
DRUMS	29	WATER SPRAY KITS/BITS	52
BITS/ACCESSORIES	29	CONVERSION KITS	53
COMPACTORS, VIBRATORY DRUM	30	DEMO CONTROL KIT	53
FORKS AND CARRIAGES	31		
HEAVY DUTY FORK CARRIAGE	31		
HEAVY DUTY FORKS	31		
HYDRAULIC POSITIONER KIT	31		
CARRIAGES	32		
PALLET FORK TINES	32		
PALLET FORKS	32		
UTILITY FORKS	33		
UTILITY GRAPPLE FORKS	33		
INDUSTRIAL GRAPPLE FORKS	33		

Throughout the brochure, abbreviations will be used for hydraulic flow capabilities for space constraints. STD Flow will be Standard Flow, HF will be High Flow, High Flow XPS will be HF XPS and High Flow XHP/XE will be XHP/XE. Attachments are compatible with all Cat Skid Steer Loader, Multi Terrain Loader and Compact Track Loader unless otherwise noted. Please contact your local Cat® dealer for exact compatibility, availability and to request a current price quote.

SKID STEER LOADERS AND COMPACT TRACK LOADERS ATTACHMENTS

Augers have the right amount of speed and torque for maximum productivity and are used for drilling holes for footings, fencing, signs, trees and shrubs in construction, agricultural and landscaping applications.



Auger Assemblies

AUGER DRIVE ASSEMBLIES

MODEL		A23	A41	A68
Overall Height	mm (in)	1020 (40)	934 (37)	978 (39)
Weight	kg (lb)	192 (423)	166 (366)	182 (401)
Drive Shaft Torque at Max Pressure	N-m (lbf)	2304 (1699)	4118 (3037)	6826 (5035)
Required Hydraulics		STD Flow	STD Flow	HF/HF XPS
Part Number		218-3178	219-7706	424-0440



Auger Drives

AUGER DRIVES

MODEL		A23	A41	A68
Overall Height	mm (in)	751 (30)	668 (26)	709 (28)
Weight	kg (lb)	90 (199)	72 (159)	98 (217)
Drive Shaft Torque at Max Pressure	N-m (lbf)	2304 (1699)	4120 (3039)	6826 (5035)
Required Hydraulics		STD Flow	STD Flow	HF/HF XPS
Part Number		225-3895	230-5578	225-8809

AUGER BRACKET

Compatibility	A23, A41, A68
Part Number	211-5044

SKID STEER LOADERS AND COMPACT TRACK LOADERS ATTACHMENTS

AUGER BITS – STANDARD DUTY

Diameter	mm (in)	102 (4)	152 (6)	229 (9)	305 (12)	381 (15)	457 (18)	610 (24)	762 (30)	914 (36)
Overall Length	mm (in)	1219 (48)	1238 (49)	1238 (49)	1278 (50)	1289 (51)	1278 (50)	1289 (51)	1278 (50)	1278 (50)
Weight	kg (lb)	18 (40)	23 (51)	34 (75)	46 (101)	50 (111)	65 (143)	92 (203)	128 (282)	173 (381)
Number of Teeth		pilot only	2	4	4	5	6	8	10	12
Part Number		366-7751	153-4083	153-4084	153-4085	366-7752	153-4086	153-4089	217-3194	153-4091

AUGER BITS – INDUSTRIAL

Diameter	mm (in)	152 (6)	229 (9)	305 (12)	406 (16)	457 (18)
Overall Length	mm (in)	1224 (48)	1219 (48)	1219 (48)	1221 (48)	1224 (48)
Weight	kg (lb)	26 (57)	33 (73)	41 (90)	52 (115)	49 (108)
Number of Teeth		2	4	4	6	6
Part Number		372-0260	372-0261	372-0262	372-0263	372-0264



**Auger Bit
Standard Duty**

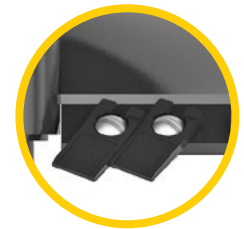

AUGER BITS – INDUSTRIAL (CONTINUED)

Diameter	mm (in)	610 (24)	762 (30)	914 (36)	1067 (42)	1219 (48)
Overall Length	mm (in)	1219 (48)	1219 (48)	1219 (48)	1219 (48)	1220 (48)
Weight	kg (lb)	68 (150)	82 (181)	101 (223)	132 (291)	156 (344)
Number of Teeth		8	10	12	16	18
Part Number		372-0265	372-0266	372-0267	372-0268	372-0269

**Auger Bit
Industrial**

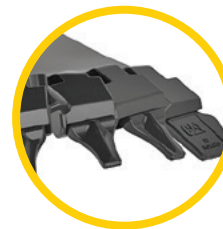

AUGER BITS – INDUSTRIAL ROCK

Diameter	mm (in)	152 (6)	229 (9)	305 (12)	406 (16)	457 (18)
Overall Length	mm (in)	1222 (48)	1222 (48)	1222 (48)	1221 (48)	1221 (48)
Weight	kg (lb)	36 (79)	49 (108)	61 (135)	76 (168)	87 (192)
Number of Teeth		8	10	12	15	16
Part Number		372-0270	372-0271	372-0272	372-0273	372-0274

AUGER BITS – INDUSTRIAL ROCK (CONTINUED)

Diameter	mm (in)	508 (20)	610 (24)	762 (30)	914 (36)
Overall Length	mm (in)	1221 (48)	1222 (48)	1222 (48)	1222 (48)
Weight	kg (lb)	99 (218)	128 (282)	141 (311)	186 (410)
Number of Teeth		17	20	24	26
Part Number		372-0275	372-0276	372-0277	372-0278



**Auger Bit
Industrial Rock**



SKID STEER LOADERS AND COMPACT TRACK LOADERS ATTACHMENTS

**Auger Bit
Tree**



AUGER BITS – TREE

Upper Diameter	mm (in)	610 (24)	914 (36)
Lower Diameter	mm (in)	305 (12)	457 (18)
Overall Length	mm (in)	1289 (51)	1288 (51)
Weight	kg (lb)	74 (163)	140 (309)
Number of Teeth		9	13
Part Number		153-4092	153-4095



**Auger Bit
Rock Head – Bolt On**

AUGER BITS – ROCK HEAD*

Flight Diameter	mm (in)	152 (6)	229 (9)	305 (12)	380 (15)	457 (18)	610 (24)
Cut Diameter	mm (in)	190 (7.5)	266 (10.5)	342 (13.5)	419 (16.5)	495 (19.5)	647 (25.5)
Overall Length	mm (in)	238 (9)	250 (10)	250 (10)	263 (10)	276 (11)	301 (12)
Weight	kg (lb)	11 (23)	15 (33)	19 (41)	21 (47)	25 (55)	36 (79)
Number of Teeth		8	10	12	14	16	20
Part Number		372-0230	372-0231	372-0232	372-0233	372-0234	372-0235

*Bolt-on rock head used with standard flights.

MESH GUARD

Part Number	211-2082
Description	Half-door mesh guard mounted to front of cab. Helps protect from flying objects.

REPLACEMENT TEETH AND HARDWARE (ALL AUGER BITS)*

Part Number	Description
153-4094	Standard Duty Tooth
174-9566	Hard Face Tooth (optional)
174-9567	Carbide Inserted Tooth (optional)
6V-8959	Bolt (1× required)
6V-7687	Locknut (1× required)

*Optional replacement teeth available through Parts only.

AUGER REPLACEMENT PARTS AND HARDWARE*

Part Number	Description
153-4093	Pilot Point/Bit
7X-2549	Bolt (1× required)
6V-7687	Locknut (1× required)

*Available through Parts only.

SKID STEER LOADERS AND COMPACT TRACK LOADERS ATTACHMENTS

SKID STEER LOADER BACKHOE**

MODEL	BH130	
Max Digging Depth	mm (in)	2972 (117)
Operating Weight	kg (lb)	1055 (2326)
Overall Length	mm (in)	2210 (87)
Overall Operating Height	mm (in)	3723 (147)
Required Hydraulics (machine)	STD Flow	
Auxiliary Hydraulics (stick)	Yes	
Smart Attachment Recognition*	Yes	
Part Number	551-6979	

*D3 Machines Only

**All listed Backhoe attachments are compatible with BH130/BH150/BH160



Backhoe

Bucket sold separately



Backhoes are used in applications such as digging footings, basements, drainage ditches, utility trenching, back-filling and maintaining slopes and embankments. They are ideal for demolishing concrete when paired with Cat® B4/B6/H55/H65 hammers.



BACKHOE MOUNTING GROUP

Part Number	Description
589-1929	Used to mount BH130 to additional D3 machines. To be bolted to machine.

Additionally, the skid steer loader backhoe attachment is also compatible with select **3 Ton** mini excavator attachments such as the ripper, hydraulic thumb, mechanical Dual Lock™ coupler, augers, buckets, compaction wheels and a vibratory plate compactor.



Ripper – 490 mm (19 in)
453-8570



Thumb – Hydraulic
452-2740



Coupler 3 Ton
Mechanical Dual Lock™
444-7494

Pins – Bucket 40 mm (1.6 in)
154-2638

SKID STEER LOADERS AND COMPACT TRACK LOADERS ATTACHMENTS



3 Ton – Auger Drives

3 TON AUGER DRIVES – BH130

MODEL		A23	A41
Overall Height	mm (in)	958 (38)	875 (34)
Weight	kg (lb)	120 (265)	92 (203)
Drive Shaft Torque at Max Pressure	N·m (lbf)	2304 (1699)	4120 (3039)
Required Hydraulics		STD Flow	STD Flow
Part Number		218-3198	220-7137

AUGER ADAPTERS AND EXTENSIONS

Description	Part Number
Adapter, Hex – 50 mm (2 in) to Round – 65 mm (2 9/16 in)	156-6329
Adapter, Round – 65 mm (2 9/16 in) to Hex – 50 mm (2 in)	217-3191
Extension, Telescoping 914 mm (3 ft)	372-0256
Extension, Telescoping 1829 mm (6 ft)	372-0257
Extension, Auger 305 mm (12 in)	156-6328
Extension, Auger 610 mm (24 in)	217-3192
Retention Pin Kit	372-0258



**Retention pin kit
372-0258**



**Extension – Telescoping
372-0256
914 mm (3 ft)**

**Extension 156-6328
305 mm (12 in)**



**Extension 217-3192
610 mm (24 in)**

**Adapter 217-3191
Round to Hex**



**Adapter 156-6329
Hex to Round**



**Extension – Telescoping
372-0257
1829 mm (6 ft)**

SKID STEER LOADERS AND COMPACT TRACK LOADERS ATTACHMENTS



3 TON DITCH CLEANING BUCKETS – BH130

Width	mm (in)	1000 (40)	1200 (47)	1200 (47)	1400 (55)
Capacity	L (ft³)	136 (4.8)	167 (5.9)	159 (5.6)	197 (7)
Weight	kg (lb)	109 (240)	107 (236)	162 (358)	118 (259)
Part Number		279-4322	279-4323	279-4325*	282-9315

*Hydraulic Angling (Requires Aux Lines)



**3 Ton
Ditch Cleaning Bucket**

3 TON HEAVY DUTY BUCKETS – BH130

Width	mm (in)	305 (12)	406 (16)	457 (18)	508 (20)
Capacity	L (ft³)	48 (1.7)	71 (2.5)	82 (2.9)	93 (3.3)
Weight	kg (lb)	65 (143)	74 (163)	82 (181)	87 (192)
Part Number		464-9900	464-9901	464-9902	464-9903



**3 Ton
Heavy Duty Bucket**

3 TON HEAVY DUTY BUCKETS – BH130 (CONTINUED)

Width	mm (in)	619 (24)	762 (30)	914 (36)
Capacity	L (ft³)	119 (4.2)	159 (5.6)	200 (7.1)
Weight	kg (lb)	98 (216)	117 (258)	133 (293)
Part Number		464-9904	464-9905	464-9906

3 TON CEMETERY BUCKET – BH130

Width	mm (in)	813 (32)
Capacity	L (ft³)	120 (4.2)
Weight	kg (lb)	124 (273)
Part Number		415-6725



**3 Ton
Cemetery Bucket**

SKID STEER LOADERS AND COMPACT TRACK LOADERS ATTACHMENTS

Cat compaction wheels provide a low cost option

for trench compaction. The wheels feature tapered roller bearings and tapered foot design for smooth operation. Six to ten passes are usually adequate to achieve compaction in normal soil conditions, dependent on the required compaction levels.



Pin on Compaction Wheel

COMPACTION WHEELS – BH130/PIN ON

Machine Class		3–4 Ton	3–4 Ton	3–4 Ton
Overall Width	mm (in)	309 (12)	399 (16)	553 (22)
Compaction Width	mm (in)	271 (11)	399 (16)	553 (22)
Overall Height	mm (in)	806 (32)	846 (33)	846 (33)
Overall Length	mm (in)	726 (29)	693 (27)	693 (27)
Weight	kg (lb)	162 (357)	224 (494)	266 (586)
Number of Wheels		2	3	4
Number of Pads		16	24	32
Part Number		517-6976	517-6977	517-6978

SKID STEER LOADERS AND COMPACT TRACK LOADERS ATTACHMENTS



Vibratory Plate Compactors are used for compacting soil, sand and gravel prior to pouring concrete or laying asphalt surfaces. Vibratory action and dynamic force provides excellent compaction in a compact size.



3 TON VIBRATORY PLATE COMPACTOR – BH130

MODEL	CVP16	
Base Plate Width	mm (in)	305 (12)
Compaction Area	m ² (ft ²)	0.19 (2)
Base Plate Length	mm (in)	610 (24)
Required Hydraulics		STD Flow
Weight	kg (lb)	216 (476)
Part Number		551-4956
Lines Gp – Pin-on		203-0977
Lines Gp – Quick Coupler		203-0981



Vibratory Plate Compactor



Bracket
532-9063



Backfill Blade
222-6443



Swivel Head
265-7461

SKID STEER LOADERS AND COMPACT TRACK LOADERS ATTACHMENTS

Bale Grabs easily transport bales of wheat, hay and other materials. The bale grab firmly grasps baled materials, but due to the rounded arm design bales are not damaged. With the ability to pick up bales sitting flat or on their side, the bale grab increases machine versatility in manipulating round or square bales in any position.



Bale Grabs

BALE GRABS

Max Opening Width	mm (in)	1803 (71)	2133 (84)
Internal Width, Arms Closed	mm (in)	940 (37)	918 (36)
Overall Width	mm (in)	1401 (55)	1401 (55)
Overall Height	mm (in)	873 (34)	873 (34)
Overall Depth	mm (in)	1150 (61)	1631 (64)
Bale Capacity	kg (lb)	1091 (2405)	1091 (2405)
Weight	kg (lb)	261 (575)	263 (580)
Required Hydraulics		STD	STD
Part Number		477-9896	489-0075



SKID STEER LOADERS AND COMPACT TRACK LOADERS ATTACHMENTS

Bale Spears are designed for loading and carrying round and square baled materials. Bales of wheat, hay and other materials can be transported for livestock feed, bedding and more. Offering optimal rigidity and capacity, the bale spear work tools are designed for a long working life.

BALE SPEARS

Tine Configuration		Single	Single	Dual	Dual
Tine Length	mm (in)	997 (39)	1251 (49)	997 (39)	1251 (49)
Overall Depth	mm (in)	1186 (47)	1443 (57)	1100 (43)	1347 (53)
Overall Width	mm (in)	1285 (51)	1285 (51)	1407 (55)	1407 (55)
Overall Height	mm (in)	570 (22)	570 (22)	1315 (52)	1315 (52)
Bale Capacity	kg (lb)	909 (2004)	909 (2004)	1364 (3007)	1364 (3007)
Weight	kg (lb)	70 (154)	72 (159)	118 (260)	121 (267)
Part Number		475-6074	475-6079	475-6070	475-6080



Bale Spears – Dual



Bale Spears – Single

Single Bale Spear



Dual Bale Spear



SKID STEER LOADERS AND COMPACT TRACK LOADERS ATTACHMENTS

Dozer Blades are designed for rough and finish grading in dirt and gravel, plus light dozing. With their 6-way capabilities, dozer blades are better suited for finish grade work in construction and landscaping applications.



Dozer Blade 6-Way

Optional Dozer Blade SMART Grading Kit provides enhanced base material cutting, moving and grading. Blade assist feature brings cross slope grading to skid steer and compact track loader platforms.



Angle Blade

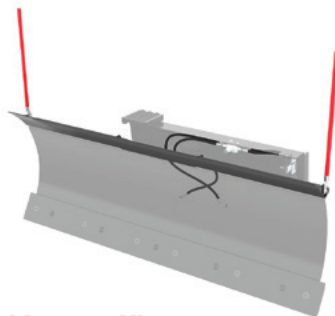

Snow and Impact Kit



DOZER BLADE 6-WAY

Blade Width	mm (in)	2007 (79)	2337 (92)	2337 (92)
Width – Fully Angled	mm (in)	1750 (69)	2049 (81)	2049 (81)
Length	mm (in)	1028 (41)	1028 (41)	1028 (41)
Weight	kg (lb)	471 (1038)	528 (1164)	528 (1164)
Required Hydraulics		STD Flow	STD Flow	HF XPS
Smart Attachment Recognition		No	No	Yes
Part Number		541-0940	541-0945	539-9210*

**279D3 HF XPS, 289D3 HF XPS and 299D3 XE machines only.*

DOZER BLADE SMART GRADING KIT

Part Number	Description
585-5125*	Includes box with sensor, connecting harness and fixings.

**Requires 539-9210 blade.*

ANGLE BLADES

Blade Width	mm (in)	1829 (72)	2134 (84)
Width Fully Angled	mm (in)	1685 (66)	1949 (77)
Length	mm (in)	753 (30)	753 (30)
Weight	kg (lb)	313 (690)	331 (730)
Required Hydraulics		STD Flow	STD Flow
Part Number		177-1989	177-1990

ANGLE BLADE SNOW AND IMPACT KIT

Part Number	Description
225-9522	For angle blade part number 177-1989
225-9523	For angle blade part number 177-1990

SKID STEER LOADERS AND COMPACT TRACK LOADERS ATTACHMENTS

Box Blades are designed for grading and leveling. Each model is designed to operate both manually and automatically with the use of laser or GPS grading systems.



BOX BLADES

MODEL		BB121	BB124
Working Width	mm (in)	2131 (84)	2436 (96)
Overall Width	mm (in)	2221 (87)	2526 (99)
Overall Length	mm (in)	2062 (81)	2062 (81)
Overall Height	mm (in)	2694 (106)	2694 (106)
Weight	kg (lb)	907 (2000)	975 (2150)
Required Hydraulics		STD Flow	STD Flow
Part Number		489-2001	489-2002

GRADER BLADES

MODEL		GB120	GB124
Working Width – wings closed	mm (in)	2148 (85)	2605 (103)
Overall Width	mm (in)	1992 (78)	2449 (96)
Overall Length	mm (in)	2246 (88)	2246 (88)
Overall Height	mm (in)	1046 (41)	1046 (41)
Weight	kg (lb)	894 (1971)	934 (2059)
Required Hydraulics		STD Flow	STD Flow
Smart Attachment Recognition		Yes	Yes
Part Number		575-2080	575-2082



Box Blade



Grader Blade



Grader Blade Wing

BLADE KITS

Part Number	Description
532-5926	BOX BLADE 8-PIN CONTROLLER KIT Includes strap on five buttons auxiliary control to operate box blade. For use with 8-pin work tool harness on machine side.
532-5927	BOX BLADE 14-PIN CONTROLLER KIT Includes strap on five buttons auxiliary control to operate box blade. For use with 14-pin work tool harness on machine side.
583-6638	GRADER WINGS KIT Left and right wings add 600 mm (24 inches) to the width of the grader blade. 205 degrees forwards and backwards.

SKID STEER LOADERS AND COMPACT TRACK LOADERS ATTACHMENTS

Angle Brooms are used for clearing parking lots, industrial plants, mill yards, airport runways, streets, driveways and lanes.



Angle Broom



ANGLE BROOMS

MODEL		BA118C	BA118C
Angling		Manual	Hydraulic
Overall Width	mm (in)	2637 (104)	2637 (104)
Sweeping Width	mm (in)	2119 (83)	2119 (83)
Height	mm (in)	918 (36)	918 (36)
Length	mm (in)	1741 (69)	1741 (69)
Weight	kg (lb)	411 (906)	433 (955)
Required Hydraulics		STD Flow	STD Flow
Part Number		448-5660	448-5670

BRISTLES

BA118C	Part Number
POLY (Yellow)	562-7622*
COLD WEATHER (Blue)	562-7623*
STEEL	562-7624*

*Kits are 1/2 of a full set. Order two for a full set.

ANGLE BROOM KITS

Part Number	Description
452-4175	BA118C WATER SPRINKLER KIT Includes six sprinkler heads, hoses, mounting hardware and quick disconnects. Requires Control-Work Tool Electrical and water tank. Not compatible with 452-4200 deflector kit.
452-4200	BA118C DEFLECTOR KIT Includes steel cowl extension, rubber debris deflector flap and mounting hardware. Not compatible with 452-4175 water sprinkler kit.
452-4195	BA118C HYDRAULIC ANGLE CONVERTER KIT Converts manual angle broom to hydraulic angle broom. Includes valve, cylinder, assembled hoses and hardware. Requires Control-Work Tool Electrical and conversion harness 377-1579 for B/B2/B3/C/C2 series machines.

SKID STEER LOADERS AND COMPACT TRACK LOADERS ATTACHMENTS



Pickup Brooms sweep and deposit materials into an integrated hopper for easy removal and dumping.



Pickup Brooms

PICKUP BROOMS

MODEL		BP115C	BP118C
Overall Width	mm (in)	1990 (78)	2295 (90)
Sweeping Width	mm (in)	1524 (60)	1829 (72)
Height	mm (in)	872 (34)	872 (34)
Length	mm (in)	1837 (72)	1837 (72)
Weight	kg (lb)	526 (1160)	570 (1257)
Required Hydraulics		STD Flow	STD Flow
Part Number		448-5680	448-5690

BRISTLES

MODEL	BP115C	BP118C
	Part Number	Part Number
POLY	562-7602*	562-7612*
COLD WEATHER (Blue)	562-7603*	562-7613*
STEEL	562-7604*	562-7614*

*Kits are 1/2 of a full set. Order two for a full set.

PICKUP BROOM KITS AND BRACKETS

Part Number	Description
452-4185*	BP115C/BP118C WATER SPRINKLER KIT Includes two sprinkler heads, hoses, hardware and quick disconnects. Requires electrical work tool control and tank.
452-4150	C SERIES GUTTER BRUSH KIT Left or right side mount. 100% wire bristles. Includes motor, brackets, assembled hoses, and fittings.
296-3649	RADIAL A-B BRACKET Supports brush frame while dumping. Includes right and left side bracket assemblies to attach to machine lift arms. Required for 216, 226, 228, 236, 246, 247, 248, 267 or 277 A and B series machines.
296-3647	BETA A-B BRACKET Supports brush frame while dumping. Includes right and left side bracket assemblies and chains to attach to machine lift arms. Required for 252, 262, 268 or 287 A and B series machines.
296-3648	ALPHA A-B BRACKET Supports brush frame while dumping. Includes right and left side bracket assemblies to attach to machine lift arms. Required for 232, 242, 257 or 259 A and B series machines.

*Requires Control-Work Tool Electrical and water tank.

SKID STEER LOADERS AND COMPACT TRACK LOADERS ATTACHMENTS

Utility Brooms sweep and collect light debris on smooth surfaces in forward or reverse travel. Recommended for spoil removal during cold planing applications.



Utility Brooms

UTILITY BROOMS

MODEL		BU115	BU118
Overall Width	mm (in)	1810 (71)	2115 (83)
Height	mm (in)	793 (31)	793 (31)
Length	mm (in)	1490 (59)	1490 (59)
Sweeping Width	mm (in)	1510 (59)	1865 (73)
Weight	kg (lb)	430 (948)	470 (1036)
Required Hydraulics		STD Flow	STD Flow
Part Number		493-2258	493-2259

UTILITY BROOM KITS/OPTIONS

Part Number	Description
242-7200	B SERIES GUTTER BRUSH Left or right side mount, 100% wire bristles. For use with BP15B/BP18B and BU115/BU118. Requires 257-5229 mounting kit if used on BU115/BU118.
257-5229	GUTTER BRUSH MOUNTING KIT For use with 242-7200 gutter brush on BU115/BU118.
257-3140	NOZZLE MOUNTING BRACKET Additional mounting brackets for sprinkler heads on utility brooms. Requires four per broom.
256-9335	WATER SPRINKLER KIT Includes four sprinkler heads, hoses, mounting hardware and quick disconnects. For use with BP15B/BP18B and BU115/BU118. Requires Control-Work Tool Electrical and water tank (cab or broom mounted). Also requires four mounting brackets (257-3140) if installing sprinkler kit on utility broom and installing cab mounted water tank.

SKID STEER LOADERS AND COMPACT TRACK LOADERS ATTACHMENTS

WATER TANK KITS

Part Number	Description
607-0593	BROOM MOUNTED WATER TANK 110 L (29 gal) For use on BU115/BU118. Requires Control-Work Tool Electrical and 377-1579 conversion harness 14-pin to 8-pin before D series (excludes B3).
346-1834	CAB MOUNTED WATER TANK 160 L (42 gal) Includes tank, pump, filter, lines, mounting brackets, quick disconnect and harness for B3 high flow machines. Requires water sprinkler kit. For use with A and B series machines.
571-6876	CAB MOUNTED WATER TANK 167 L (44 gal) For use with D, D2 and D3 series machines. Requires water sprinkler kit. Cannot be used with four-point lifting eye kit, single point lift kit, FOPS level 2 kit, FOPS level 2 with 4-point lift, or auxiliary hydraulic cooler kit.

INDUSTRIAL BRUSHCUTTERS

MODEL		BRX118	BRX318	BRX418
Overall Width	mm (in)	1911 (75)	1911 (75)	1911 (75)
Cutting Width	mm (in)	1829 (72)	1829 (72)	1829 (72)
Maximun Cutting Diameter	mm (in)	203 (8)	203 (8)	203 (8)
Overall Height	mm (in)	733 (29)	733 (29)	733 (29)
Overall Length	mm (in)	2170 (85)	2170 (85)	2170 (85)
Weight	kg (lb)	1072 (2363)	1072 (2363)	1072 (2363)
Required Hydraulics		STD Flow	HF XPS	XHP/XE
Part Number		523-5560	523-5570	523-5580



Industrial Brushcutters

Industrial Brushcutters are designed for land management, utilities, site prep and maintenance work for brush, small trees and dense vegetation.



SKID STEER LOADERS AND COMPACT TRACK LOADERS ATTACHMENTS

Brushcutters are used for clearing overgrowth from highway medians, utility easements and for initial land clearing for housing, parks and recreational areas.



BRUSHCUTTERS

MODEL		BR115	BR117	BR118	BR218	BR320
Overall Width	mm (in)	1575 (62)	1727 (68)	1880 (74)	1880 (74)	2032 (80)
Cutting Width	mm (in)	1524 (60)	1676 (66)	1829 (72)	1829 (72)	1981 (78)
Maximum Cutting Diameter	mm (in)	76 (3)	76 (3)	76 (3)	76 (3)	76 (3)
Overall Height	mm (in)	533 (21)	533 (21)	518 (20)	518 (20)	531 (21)
Overall Length	mm (in)	1854 (73)	2007 (79)	2159 (85)	2159 (85)	2311 (91)
Weight	kg (lb)	431 (950)	476 (1049)	499 (1100)	508 (1120)	535 (1180)
Required Hydraulics		STD Flow	STD Flow	STD Flow	High Flow	HF XPS
Part Number		264-9500	264-9600	264-9400	424-0435	424-0436



Brushcutter

SKID STEER LOADERS AND COMPACT TRACK LOADERS ATTACHMENTS

CONCRETE SLAB BUCKET WITH BOLT-ON TEETH

Width	mm (in)	607 (24)
Maximum Slab Thickness	mm (in)	202 (8)
Height	mm (in)	460 (18)
Length	mm (in)	1332 (52)
Weight	kg (lb)	210 (463)
Part Number		598-2232



Concrete Slab Bucket

GENERAL PURPOSE BUCKETS WITH BOLT-ON CUTTING EDGE

Width	mm (in)	1576 (62)	1730 (68)	1883 (74)	2036 (80)	2188 (86)
Capacity	m ³ (yd ³)	0.36 (0.47)	0.4 (0.52)	0.44 (0.58)	0.48 (0.63)	0.63 (0.82)
Height	mm (in)	426 (17)	426 (17)	426 (17)	426 (17)	469 (19)
Length	mm (in)	708 (28)	708 (28)	708 (28)	708 (28)	797 (31)
Weight	kg (lb)	200 (441)	250 (551)	271 (598)	286 (631)	328 (723)
Part Number		279-5365	279-5369	279-5373	279-5377	296-8192



General Purpose Bucket with Bolt-On Cutting Edge

GENERAL PURPOSE BUCKETS WITH BOLT-ON TEETH

Width	mm (in)	1576 (62)	1730 (68)	1883 (74)	2036 (80)	2188 (86)
Capacity	m ³ (yd ³)	0.36 (0.47)	0.4 (0.52)	0.44 (0.58)	0.48 (0.63)	0.63 (0.82)
Height	mm (in)	426 (17)	426 (17)	426 (17)	426 (17)	469 (19)
Length	mm (in)	708 (28)	708 (28)	708 (28)	708 (28)	797 (31)
Weight	kg (lb)	185 (408)	231 (509)	249 (549)	264 (582)	304 (670)
Part Number		279-5366	279-5370	279-5374	279-5378	296-8191



General Purpose Bucket with Bolt-On Teeth

INDUSTRIAL PERFORMANCE BUCKETS WITH BOLT-ON CUTTING EDGE

Width	mm (in)	1730 (68)	1883 (74)	2036 (80)	2188 (86)	2340 (92)
Capacity	m ³ (yd ³)	0.52 (0.68)	0.57 (0.75)	0.62 (0.81)	0.67 (0.88)	0.72 (0.94)
Height	mm (in)	568 (22)	566 (22)	566 (22)	566 (22)	566 (22)
Length	mm (in)	1022 (40)	1022 (40)	1022 (40)	1022 (40)	1022 (40)
Weight	kg (lb)	318 (701)	336 (741)	353 (778)	370 (816)	388 (855)
Part Number		532-7738	532-7741	532-7744	532-7747	532-7750



Industrial Performance Buckets with Bolt-On Cutting Edge

INDUSTRIAL PERFORMANCE BUCKETS WITH BOLT-ON TEETH

Width	mm (in)	1730 (68)	1883 (74)	2036 (80)	2188 (86)	2340 (92)
Capacity	m ³ (yd ³)	0.52 (0.68)	0.57 (0.75)	0.62 (0.81)	0.67 (0.88)	0.72 (0.94)
Height	mm (in)	551 (22)	550 (22)	550 (22)	550 (22)	550 (22)
Length	mm (in)	1092 (43)	1092 (43)	1092 (43)	1092 (43)	1092 (43)
Weight	kg (lb)	301 (664)	315 (695)	331 (730)	346 (763)	361 (796)
Part Number		532-7739	532-7742	532-7745	532-7748	532-7751



Industrial Performance Buckets with Bolt-On Teeth

SKID STEER LOADERS AND COMPACT TRACK LOADERS ATTACHMENTS



Light Material Buckets

LIGHT MATERIAL BUCKETS WITH BOLT-ON CUTTING EDGE

Width	mm (in)	1883 (74)	2036 (80)	2185 (86)	2490 (98)
Capacity	m ³ (yd ³)	0.69 (0.9)	0.75 (0.98)	0.84 (1.1)	0.93 (1.22)
Height	mm (in)	695 (27)	695 (27)	695 (27)	695 (27)
Length	mm (in)	828 (33)	828 (33)	828 (33)	828 (33)
Weight	kg (lb)	302 (666)	320 (706)	339 (747)	373 (822)
Part Number		279-5420	279-5425	279-5430	296-7597



Low Profile Buckets with Bolt-On Cutting Edge

LOW PROFILE BUCKETS WITH BOLT-ON CUTTING EDGE

Width	mm (in)	1421 (56)	1586 (62)	1740 (68)	1893 (74)	2045 (80)
Capacity	m ³ (yd ³)	0.3 (0.39)	0.34 (0.44)	0.37 (0.48)	0.41 (0.54)	0.44 (0.58)
Height	mm (in)	536 (21)	542 (21)	542 (21)	542 (21)	542 (21)
Length	mm (in)	722 (28)	722 (28)	722 (28)	722 (28)	722 (28)
Weight	kg (lb)	178 (392)	205 (452)	232 (512)	248 (547)	265 (584)
Part Number		279-5435	279-5438	279-5441	285-6090	268-4083



Material Handling Buckets

MATERIAL HANDLING BUCKETS WITH BOLT-ON CUTTING EDGE

Width	mm (in)	2185 (86)	2490 (98)	2642 (104)
Capacity	m ³ (yd ³)	1.07 (1.4)	1.25 (1.63)	1.33 (1.74)
Height	mm (in)	757 (30)	757 (30)	757 (30)
Length	mm (in)	1031 (41)	1031 (41)	1031 (41)
Weight	kg (lb)	365 (805)	400 (882)	418 (922)
Part Number		472-2546	472-2548	469-0774



Multi Purpose Buckets with Bolt-On Cutting Edge

MULTI PURPOSE BUCKETS WITH BOLT-ON CUTTING EDGE

Width	mm (in)	1576 (62)	1730 (68)	1883 (74)	2036 (80)	2188 (86)
Capacity	m ³ (yd ³)	0.3 (0.39)	0.34 (0.44)	0.37 (0.48)	0.4 (0.52)	0.43 (0.56)
Height	mm (in)	388 (15)	388 (15)	388 (15)	388 (15)	388 (15)
Length	mm (in)	724 (29)	724 (29)	724 (29)	724 (29)	724 (29)
Weight	kg (lb)	386 (851)	411 (906)	436 (961)	461 (1016)	486 (1071)
Part Number		431-5570	426-6490	426-6536	426-6548	426-6558



Multi Purpose Buckets with Bolt-On Teeth

MULTI PURPOSE BUCKETS WITH BOLT-ON TEETH

Width	mm (in)	1576 (62)	1730 (68)	1883 (74)	2036 (80)	2188 (86)
Capacity	m ³ (yd ³)	0.3 (0.39)	0.34 (0.44)	0.37 (0.48)	0.4 (0.52)	0.43 (0.56)
Height	mm (in)	388 (15)	388 (15)	388 (15)	388 (15)	388 (15)
Length	mm (in)	696 (27)	724 (29)	724 (29)	724 (29)	724 (29)
Weight	kg (lb)	371 (818)	394 (869)	416 (917)	440 (970)	462 (1019)
Part Number		423-4287	426-6487	426-6535	426-6547	426-6557

SKID STEER LOADERS AND COMPACT TRACK LOADERS ATTACHMENTS

SKELETON BUCKETS – PLATE TINE STYLE

Width	mm (in)	1849 (73)	2017 (79)	2182 (86)	2349 (93)
Height	mm (in)	544 (21)	544 (21)	544 (21)	544 (21)
Length	mm (in)	1115 (44)	1115 (44)	1115 (44)	1115 (44)
Weight	kg (lb)	317 (699)	342 (754)	365 (805)	382 (842)
Part Number		553-2143	563-1393	563-1400	564-3039



**Skeleton Buckets
Plate Tine Style**

SKELETON BUCKETS – ROD TINE STYLE

Width	mm (in)	2016 (79)	2206 (87)	2397 (94)
Height	mm (in)	644 (25)	644 (25)	644 (25)
Length	mm (in)	1199 (47)	1199 (47)	1199 (47)
Weight	kg (lb)	336 (741)	363 (800)	390 (860)
Part Number		549-6561	549-6563	549-6565



**Skeleton Buckets
Rod Tine Style**

INDUSTRIAL GRAPPLE BUCKETS

Width	mm (in)	1576 (62)	1730 (68)	1883 (74)	2036 (80)
Length	mm (in)	749 (30)	749 (30)	749 (30)	749 (30)
Height – Grapples Closed	mm (in)	525 (21)	525 (21)	525 (21)	525 (21)
Jaw Opening	mm (in)	1016 (40)	1016 (40)	1016 (40)	1016 (40)
Weight	kg (lb)	482 (1063)	504 (1111)	526 (1160)	545 (1202)
Required Hydraulics		STD Flow	STD Flow	STD Flow	STD Flow
Part Number		157-7226	157-7227	158-6095	217-6230



Industrial Grapple Buckets

UTILITY BUCKETS WITH BOLT-ON CUTTING EDGE

Width	mm (in)	1576 (62)	1730 (68)	1883 (74)
Capacity	m ³ (yd ³)	0.43 (0.56)	0.48 (0.63)	0.52 (0.68)
Height	mm (in)	533 (21)	533 (21)	533 (21)
Length	mm (in)	789 (31)	789 (31)	789 (31)
Weight	kg (lb)	240 (529)	258 (569)	276 (609)
Part Number		285-6095	285-6100	285-6101



Utility Buckets

UTILITY GRAPPLE KIT

Part Number	Description
285-6116	One cylinder, one grapple assembly



Utility Grapple Kit

UTILITY GRAPPLE BUCKETS

Width	mm (in)	1730 (68)	1883 (74)
Length	mm (in)	789 (31)	789 (31)
Height – Grapple Closed	mm (in)	533 (21)	533 (21)
Jaw Opening	mm (in)	902 (36)	902 (36)
Capacity	m ³ (yd ³)	0.48 (0.63)	0.52 (0.68)
Weight	kg (lb)	365 (805)	382 (842)
Required Hydraulics		STD Flow	STD Flow
Part Number		285-6111	285-6112



Utility Grapple Buckets

SKID STEER LOADERS AND COMPACT TRACK LOADERS ATTACHMENTS

Concrete Slab Bucket



Plate Tine Skeleton Bucket



Multi Purpose Bucket

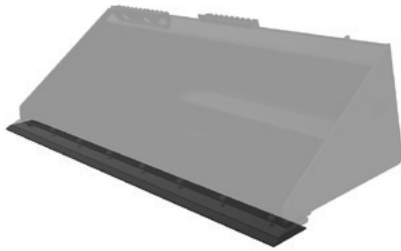

Cutting Edges

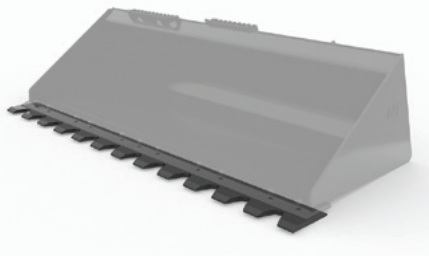

Serrated Edges

BUCKET CUTTING EDGES* – STEEL

Part Number	Bucket Width – mm (in)	Required Sets of Hardware
135-9394	1576 (62)	8
135-9395	1730 (68)	8
135-9396	1883 (74)	11
135-9397	2036 (80)	11
195-5124	2188 (86)	11
538-2280	2340 (92)	9
296-7602	2490 (98)	13
469-4306	2642 (104)	13

**Please order direct from Parts.*

BUCKET SERRATED EDGES*

Part Number	Bucket Width – mm (in)	Required Sets of Hardware
319-9599	1576 (62)	8
319-9600	1760 (68)	8
319-9601	1883 (74)	11
319-9602	2036 (80)	11
319-9603	2188 (86)	7
540-3531	2340 (92)	9
491-5963	2490 (98)	13
491-5964	2642 (104)	13

**Please order direct from Parts.*

SERRATED EDGE HARDWARE—ONE SET* (REQUIRED)

Part Number	Description	Quantity
8T-4778	Nut (1×)	1
159-2953	Screw, Flat Head (1×)	1

**Please order direct from Parts.*

SKID STEER LOADERS AND COMPACT TRACK LOADERS ATTACHMENTS

BUCKET TOOTH BAR MOUNTING HARDWARE*** (REQUIRED)

Part Number	Description	Quantity
2J-3507	Nut	2
3B-4516	Lock washer	2
5P-8250	Washer	2
8S-9093	Bolt	2

***Please order direct from Parts.



BUCKET TOOTH BARS – FOR USE WITH BASE EDGE*

Part Number	Bucket Width – mm (in)	Quantity of Uni Teeth
136-8734	1576 (62)	7
136-8735	1760 (68)	8
136-8736	1883 (74)	8
217-4878	2036 (80)	8
275-5427	2188 (86)	8
566-2844	2340 (92)	8

*Series 1: Please order direct from Parts.

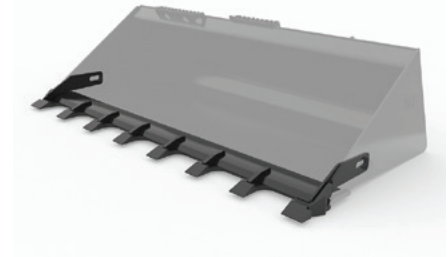

BUCKET TOOTH BARS – FOR USE WITH CUTTING EDGE**

Part Number	Bucket Width – mm (in)	Quantity of Uni Teeth
159-0330	1576 (62)	7
159-0340	1760 (68)	8
159-0350	1883 (74)	8
195-9160	2036 (80)	8
264-2084	2188 (86)	8
566-1841	2340 (92)	8

**Series 2: Please order direct from Parts.

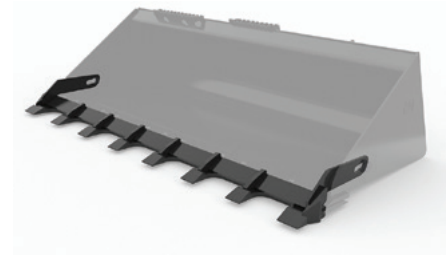

REPLACEMENT BUCKET BOLT-ON TEETH*

Part Number	Bucket Width – mm (in)	Required Uni Teeth per Bucket
141-4999	1576 (62)	8
141-4999	1730 (68)	8
141-4999	1883 (74)	8
141-4999	2036 (80)	9
141-4999	2188 (86)	9
141-4999	2340 (92)	9

*Please order direct from Parts.



SKID STEER LOADERS AND COMPACT TRACK LOADERS ATTACHMENTS

MIXING BUCKETS

MODEL		MB200	MB250
Capacity	m ³ (yd ³)	0.2 (0.26)	0.25 (0.33)
Overall Width	mm (in)	1602 (63)	1605 (63)
Height	mm (in)	731 (29)	877 (35)
Length	mm (in)	694 (27)	814 (32)
Weight	kg (lb)	290 (639)	430 (948)
Required Hydraulics		STD Flow	STD Flow
Part Number		489-2150*	489-2200*

*Requires four button left hand joystick and 14 pin harness.



Mixing Buckets



Side Discharge Bucket

Side Discharge Buckets

collect and discharge sawdust, mulch, straw and sand into barns, stalls and orchards, backfill topsoil or pea gravel into trenches and spread silage. The left or right discharge design eliminates the need for awkward maneuvering, saving time.

SIDE DISCHARGE BUCKETS

MODEL		BD118 SAWDUST	BD121 SAWDUST	BD118 SAND	BD121 SAND
Width	mm (in)	1860 (73)	2165 (85)	1860 (73)	2165 (85)
Capacity	m ³ (yd ³)	1.53 (2)	1.78 (2.3)	0.76 (1)	1.02 (1.3)
Height	mm (in)	1118 (44)	1118 (44)	867 (34)	867 (34)
Length	mm (in)	1451 (57)	1451 (57)	1269 (50)	1269 (50)
Weight	kg (lb)	535 (1180)	579 (1277)	480 (1058)	522 (1151)
Required Hydraulics		STD Flow	STD Flow	STD Flow	STD Flow
Part Number		477-9895	479-8085	479-8095	479-8105

Cold Planers

are designed for small paving jobs in residential and commercial applications and are primarily used to economically restore asphalt and concrete surfaces.



Cold Planers

COLD PLANERS					
MODEL		PC104	PC105	PC305	PC306
Working Width	mm (in)	350 (14)	450 (18)	450 (18)	600 (24)
Overall Width	mm (in)	1728 (68)	1728 (68)	1858 (73)	1858 (73)
Overall Length	mm (in)	1117 (44)	1182 (47)	1248 (49)	1248 (49)
Overall Height	mm (in)	941 (37)	928 (37)	930 (37)	930 (37)
Max Cutting Depth	mm (in)	150 (6)	150 (6)	170 (7)	170 (7)
Required Hydraulics		STD Flow	STD Flow	HF/HF XPS	HF/HF XPS
Weight	kg (lb)	682 (1504)	739 (1629)	848 (1870)	956 (2108)
Part Number		529-5760	529-5770	529-5780	529-5790

COLD PLANERS (CONTINUED)						
MODEL		PC306 Water	PC310	PC306 XD	PC310 XD	PC406
Working Width	mm (in)	600 (24)	1000 (39)	600 (24)	1000 (39)	600 (24)
Overall Width	mm (in)	1858 (73)	1858 (73)	1858 (73)	1858 (73)	1858 (73)
Overall Length	mm (in)	1432 (56)	1125 (44)	1576 (62)	1498 (59)	1270 (50)
Overall Height	mm (in)	930 (37)	935 (37)	1113 (44)	1099 (43)	951 (37)
Max Cutting Depth	mm (in)	170 (7)	130 (5)	250 (10)	220 (9)	170 (7)
Required Hydraulics		HF/HF XPS	HF XPS	HF XPS	HF XPS	XHP/XE
Weight	kg (lb)	1218 (2685)	1040 (2293)	1410 (3109)	1741 (3838)	987 (2176)
Part Number		529-5791	529-5820	529-5840	529-5850	529-5800

SKID STEER LOADERS AND COMPACT TRACK LOADERS ATTACHMENTS

COLD PLANERS (CONTINUED)

MODEL		PC406 Water	PC408	PC412
Working Width	mm (in)	600 (24)	750 (30)	1200 (47)
Overall Width	mm (in)	1858 (73)	1858 (73)	1858 (73)
Overall Length	mm (in)	1453 (57)	1270 (50)	1140 (45)
Overall Height	mm (in)	951 (37)	951 (37)	935 (37)
Max Cutting Depth	mm (in)	170 (7)	170 (7)	130 (5)
Required Hydraulics		XHP/XE	XHP/XE	XHP/XE
Weight	kg (lb)	1249 (2754)	1045 (2304)	1160 (2557)
Part Number		529-5801	529-5810	529-5830

**Cold Planers with
Water Tank**



Water Tank Kit



KITS – WATER TANK

Part Number	Description
591-0703*	PC 160 L (42 gal) WATER TANK KIT Integrated solution consists of frame with water tank inside with a skid steer coupler interface on the outside. This replaces the existing skid steer coupler interface on the cold planer. For use on PC104, PC105, PC305, PC306, PC310, PC408, PC412.

*Requires water spray kit and work tool harness.

KITS – WATER SPRAY

Part Number	Description
231-2590*	PCX03/4/5 WATER SPRAY KIT Includes two sprinkler heads, hoses, mounting hardware and quick disconnects. For use with PC104B, PC104, PC105, PC203, PC204, PC205, PC205B, PC305B, PC305.
231-2591*	PCX06/8 WATER SPRAY KIT Includes three sprinkler heads, hoses, mounting hardware and quick disconnects. For use with PC206, PC306B, PC306, PC406, PC408B, PC408.
231-2592*	PC210/310B WATER SPRAY KIT Includes four sprinkler heads, hoses, mounting hardware and quick disconnects.
381-8341*	PC412B WATER SPRAY KIT Includes five sprinkler heads, hoses, mounting hardware and quick disconnects.
591-0710*	PC310 WATER SPRAY KIT Includes four sprinkler heads, hoses, mounting hardware and quick disconnects.
591-0712*	PC412 WATER SPRAY KIT Includes five sprinkler heads, hoses, mounting hardware and quick disconnects.

*Requires Control-Work Tool Electrical and integrated/machine-mounted water tank.

SKID STEER LOADERS AND COMPACT TRACK LOADERS ATTACHMENTS

COLD PLANER DRUMS

Part Number	Description – Width	Cut Depth Minimum	Cut Depth Maximum	Bits	Compatibility
231-2572	Asphalt – 75 mm (3 in)	50 mm (2 in)	200 mm (8 in)	24	PC104, PC105, PC104B, PC203, PC204, PC205, PC205B
231-2573	Asphalt – 150 mm (6 in)	50 mm (2 in)	200 mm (8 in)	24	PC104, PC105, PC104B, PC203, PC204, PC205, PC205B
231-2574	Asphalt – 200 mm (8 in)	50 mm (2 in)	200 mm (8 in)	36	PC104, PC105, PC104B, PC203, PC204, PC205, PC205B
231-2575	Asphalt – 300 mm (12 in)	50 mm (2 in)	200 mm (8 in)	42	PC104, PC105, PC104B, PC203, PC204, PC205, PC205B
231-2580	Asphalt – 75 mm (3 in)	50 mm (2 in)	200 mm (8 in)	24	PC206, PC305, PC306, PC305B, PC306B
231-2581	Asphalt – 150 mm (6 in)	50 mm (2 in)	200 mm (8 in)	28	PC206, PC305, PC306, PC305B, PC306B
606-2524	Asphalt – 300 mm (12 in)	50 mm (2 in)	215 mm (8.5 in)	42	PC305, PC305B
231-2583	Asphalt – 300 mm (12 in)	50 mm (2 in)	200 mm (8 in)	42	PC206, PC306, PC306B
224-7360	Asphalt – 450 mm (18 in)	0 mm (0 in)	150 mm (6 in)	48	PC105, PC204, PC205, PC205B
231-2586	Asphalt – 450 mm (18 in)	50 mm (2 in)	200 mm (8 in)	48	PC206, PC306, PC306B
224-7384	Asphalt – 600 mm (24 in)	0 mm (0 in)	170 mm (7 in)	60	PC206, PC306, PC306B
467-8067	Fine Tooth Kit – 600 mm (24 in)	0 mm (0 in)	30 mm (1.2 in)	208	PC205, PC205B, PC105
467-8068	Fine Tooth Kit – 600 mm (24 in)	0 mm (0 in)	30 mm (1.2 in)	308	PC206, PC306B, PC306
467-8069	Fine Tooth Kit – 1000 mm (40 in)	0 mm (0 in)	30 mm (1.2 in)	508	PC210, PC310B, PC310



Cold Planer Drum

BITS/ACCESSORIES

Part Number	Description
561-8134	All Purpose bit (asphalt and concrete)
561-8132	Concrete bit
560-2306	Heavy Duty Asphalt bit
226-9308	Block Holder for bit
543-5470	Punch (bit remover)
539-6298	Puller Fork (bit remover)



**Heavy Duty
Asphalt Bit**



Concrete Bit



**All Purpose Bit
(Asphalt/Concrete)**

SKID STEER LOADERS AND COMPACT TRACK LOADERS ATTACHMENTS

Vibratory Drum Compactors

produce a vibratory action and dynamic force that provides excellent compaction for soil, sand or gravel prior to pouring concrete or laying asphalt surfaces. They are also ideal for asphalt patch work.



VIBRATORY DRUM COMPACTORS			
MODEL		CV117	CV119
Drum Width	mm (in)	1676 (66)	1854 (73)
Overall Width	mm (in)	1854 (73)	2032 (80)
Weight	kg (lb)	936 (2064)	970 (2139)
Required Hydraulics		STD Flow	STD Flow
Part Number		231-8600	231-8601



Vibratory Drum Compactors

Heavy Duty Forks and Fork Carriage are designed to meet a wide variety of palletized material handling needs that are above what standard duty fork carriages can handle.



Heavy Duty Fork Carriage

HEAVY DUTY FORK CARRIAGE – CLASS 2

Overall Width	mm (in)	1438 (57)
Length	mm (in)	277 (11)
Height	mm (in)	910 (36)
Weight	kg (lb)	145 (320)
Tine Spacing Range	mm (in)	414-1266 (16-50)
Part Number		532-7810



Heavy Duty Forks

HEAVY DUTY FORKS – CLASS 2

Tine Length	mm (in)	1067 (42)	1219 (48)	1524 (60)
Overall Length	mm (in)	1141 (45)	1293 (51)	1598 (63)
Width	mm (in)	122 (5)	122 (5)	122 (5)
Height	mm (in)	549 (22)	549 (22)	549 (22)
Weight	kg (lb)	118 (260)	132 (291)	158 (348)
Part Number		540-1431	540-1432	540-1433

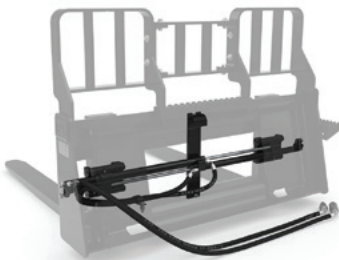

Heavy Duty Hydraulic Positioner

KIT – HEAVY DUTY HYDRAULIC POSITIONER

Part Number	Description
556-3173	Allows fork tine spacing adjustment from within the machine. For use with heavy duty carriage 532-7810.

SKID STEER LOADERS AND COMPACT TRACK LOADERS ATTACHMENTS

CARRIAGES – CLASS 2

Width	mm (in)	1270 (50)
Length	mm (in)	261 (10)
Height	mm (in)	912 (36)
Weight	kg (lb)	94 (207)
Max Tine Spacing	mm (in)	1008 (40)
Part Number		351-9371



Pallet Fork Carriage

PALLET FORK TINES – CLASS 2

Tine Length	mm (in)	910 (36)	914 (36)	1070 (42)	1070 (42)	1220 (48)	1220 (48)
Overall Length	mm (in)	979 (39)	979 (39)	1139 (45)	1139 (45)	1294 (51)	1289 (51)
Width	mm (in)	100 (4)	100 (4)	100 (4)	100 (4)	100 (4)	100 (4)
Height	mm (in)	541 (21)	541 (21)	541 (21)	541 (21)	541 (21)	541 (21)
Weight	kg (lb)	39 (86)	42 (92)	44 (97)	47 (104)	51 (112)	52 (114)
Type		Hook	Pull	Hook	Pull	Hook	Pull
Part Number		151-5134*	195-6943*	149-1412*	195-6942*	161-2437*	195-8545*

*Order two for a pair.

PALLET FORKS

Tine Length	mm (in)	1070 (42)	1220 (48)
Carriage Height	mm (in)	934 (37)	934 (37)
Carriage Width	mm (in)	1164 (46)	1164 (46)
Tine Width	mm (in)	100 (4)	100 (4)
Tine Thickness	mm (in)	40 (2)	40 (2)
Operating Weight	kg (lb)	186 (410)	195 (430)
Overall Length	mm (in)	1332 (52)	1482 (58)
Max Tine spacing (center to center)	mm (in)	1008 (40)	1008 (40)
Part Number		618-5109	618-5110

NOTE: 353-1696 Pallet with three carriages (351-9371) and six tines/forks, 1070 mm (42 in).
353-1697 Pallet with three carriages (351-9371) and six tines/forks, 1220 mm (48 in).

Pallet Fork Tine

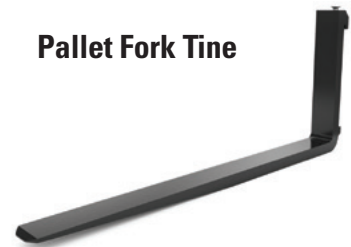

Pallet Forks

SKID STEER LOADERS AND COMPACT TRACK LOADERS ATTACHMENTS



Utility Forks

UTILITY FORKS

Width	mm (in)	1676 (66)	1829 (72)
Length	mm (in)	924 (36)	924 (36)
Height	mm (in)	581 (23)	581 (23)
Tine Diameter	mm (in)	32 (1)	32 (1)
Number of Tines		7	9
Weight	kg (lb)	198 (437)	220 (485)
Part Number		285-6105	285-6110



Utility Grapple Forks

UTILITY GRAPPLE FORKS

Width	mm (in)	1676 (66)	1829 (72)
Length	mm (in)	939 (37)	939 (37)
Usable Tine Length	mm (in)	637 (25)	637 (25)
Tine Diameter	mm (in)	32 (1)	32 (1)
Jaw Opening	mm (in)	876 (35)	876 (35)
Weight	kg (lb)	305 (672)	326 (719)
Required Hydraulics		STD Flow	STD Flow
Part Number		285-6114	285-6115



Industrial Grapple Forks

INDUSTRIAL GRAPPLE FORKS

Width	mm (in)	1676 (66)	1829 (72)
Length	mm (in)	927 (37)	927 (37)
Height – Grapples Closed	mm (in)	810 (32)	814 (32)
Jaw Opening	mm (in)	965 (38)	965 (38)
Tine Diameter	mm (in)	45 (2)	45 (2)
Usable Tine Length	mm (in)	553 (22)	553 (22)
Number of Tines		9	11
Weight	kg (lb)	502 (1107)	548 (1208)
Required Hydraulics		STD Flow	STD Flow
Part Number		279-5350	279-5360

SKID STEER LOADERS AND COMPACT TRACK LOADERS ATTACHMENTS

Hammers are high performance breakers, designed for maximum performance on demolition, construction and road work.



Hammers
(Two tools included)



Hammer Tool Kit
(Included with all hammers)

HAMMERS					
MODEL		B4	B4s	B6	B6s
Height Without Tool	mm (in)	830 (33)	865 (34)	948 (37)	999 (39)
Overall Height	mm (in)	1190 (47)	1195 (47)	1375 (54)	1370 (54)
Overall Length	mm (in)	300 (11.8)	300 (11.8)	316 (12.4)	316 (12.4)
Overall Width	mm (in)	340 (13)	340 (13)	440 (17)	440 (17)
Tool Shaft Diameter	mm (in)	53 (2.1)	53 (2.1)	68 (2.7)	68 (2.7)
Operating Weight – With Tool	kg (lb)	159 (351)	162 (357)	259 (571)	277 (611)
Minimum Operating Pressure	bar (psi)	103 (1492)	103 (1492)	122 (1775)	122 (1775)
Sound – dB		128	124	128	124
Required Hydraulics		STD Flow	STD Flow	STD Flow	STD Flow
Part Number		532-9104*	532-9204*	532-9106**	532-9206**

*Requires poly door plus hammer-side mounting bracket (small or medium) and connecting lines.

**Requires poly door plus hammer-side mounting bracket (large) and connecting lines.

HAMMERS (CONTINUED)					
MODEL		B8	B8s	H55s	H65s
Height Without Tool	mm (in)	1005 (40)	1044 (41)	784 (31)	953 (38)
Overall Height	mm (in)	1413 (56)	1402 (55)	1108 (44)	1324 (52)
Overall Length	mm (in)	316 (12)	316 (12)	451 (18)	451 (18)
Overall Width	mm (in)	440 (17)	440 (17)	346 (14)	346 (14)
Tool Shaft Diameter	mm (in)	75 (3)	75 (3)	58 (2.3)	68 (2.7)
Operating Weight – With Tool	kg (lb)	350 (771)	344 (758)	345 (761)	390 (860)
Minimum Operating Pressure	bar (psi)	117 (1704)	117 (1704)	100 (1450)	100 (1450)
Sound – dB		133	129	120	124
Required Hydraulics		STD Flow	STD Flow	STD Flow	STD Flow
Part Number		532-9108**	532-9208**	561-2551**	561-2552**

**Requires machine-side hammer lines and front guards, plus hammer-side mounting bracket (large) and connecting lines.

SKID STEER LOADERS AND COMPACT TRACK LOADERS ATTACHMENTS

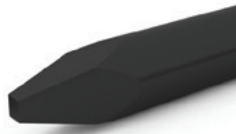

MOIL



**CHISEL
INLINE**

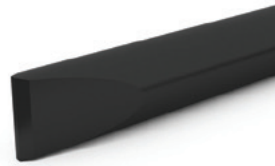

**CHISEL
CROSSCUT**



CONE

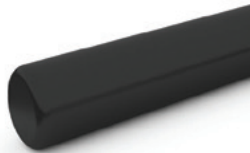

BLUNT

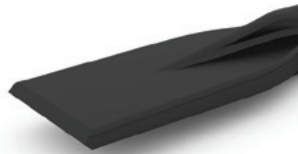

**SPADE
PARALLEL**



**SPADE
TRANSVERSE**



**COMPACTING
PLATE**

HAMMER TOOLS

Tool	B4	B6	B8	H55s	H65s
Moil	532-9190	523-3193	532-9120	—	—
Chisel, Inline	542-1760	523-3191	532-9121	423-8310	423-8307
Chisel, Crosscut	542-1761	523-3197	532-9119	428-8024	428-8022
Cone	542-1758	523-3195	532-9118	423-8312	423-8308
Blunt	542-1759	523-3196	532-9117	423-8314	423-8309
Spade Parallel	582-1497	582-1498	582-1499	433-9655	433-9653
Spade Transverse	582-1502	582-1503	582-1504	433-9654	433-9652
Compacting Plate	582-1492	582-1493	582-1494	433-9648	433-9651

SKID STEER LOADERS AND COMPACT TRACK LOADERS ATTACHMENTS

HAMMER BRACKETS/LINES

Part Number	Description
 532-9240	SKID STEER LOADER BRACKET, LINES, MEDIUM-LARGE Bracket with skid steer interface, including lines and quick disconnects. For use with B model hammers with drill pattern medium or large.
 532-9250	SKID STEER LOADER BRACKET, MEDIUM-LARGE Bracket with skid steer interface. For use with B and H model hammers with drill pattern medium or large. Requires connecting lines and quick disconnects.
 532-9264	B4, B6, B8 HAMMER LINES Connecting lines, including quick disconnects. Cannot be used with H model hammers.
 532-9059	3-TON BRACKET, 40 MM (1.6 IN), SMALL-MEDIUM For use with BH130 and BH160 and hammers with drill pattern small or medium, pin-on, stick mounted or with Dual Lock™ pin grabber quick couplers. Includes bolts, nuts and bucket pins.
 532-9063	3-TON BRACKET, 40 MM (1.6 IN), SMALL-LARGE For use with BH130 and BH160 and hammers with drill pattern small or large and pin-on stick mounted with 3-ton linkage.
 532-9088	3-TON HAMMER LINES For use with BH130 and BH160.
 532-9249	PIN ON SKID STEER LOADER BRACKET Skid steer loader bracket for use with B4/B6/B8 and H55/H65 flat top, pin-on hammers. Requires bracket 532-9275.
 532-9275	3-5 TON BRACKET, MEDIUM-LARGE Bracket with drill pattern medium-large. For use with flat top, pin-on H55/H65.
269-7271	H55, H65 HAMMER LINES, SKID STEER LOADER For use with H55/H65 (pin-on/flat top) and 532-9250 skid steer loader bracket, medium-large. Cannot be used with B model hammers.

SKID STEER LOADERS AND COMPACT TRACK LOADERS ATTACHMENTS

LEGACY BRACKETS/MOUNTING GROUPS/LINES

Part Number	Description
356-3241	SKID STEER LOADER BRACKET for C and D series machines.
249-1144	2-TON SKID STEER LOADER MOUNTING GROUP Includes two bucket pins, four retention pins and four bushings. For use on skid steer loaders with BH30/BH30W and H55E pin-on.
249-1145	3-TON SKID STEER LOADER MOUNTING GROUP Includes two bucket pins, four retention pins and four bushings. For use on skid steer loaders with BH160 and H55E/H65E pin-on.
270-8680	H55D/H55E PIN-ON, LINES, 2-TON STANDARD STICK Includes hose assemblies, quick disconnects and connectors. For use on skid steer loaders with BH30/BH30W and pin-on H55D/E.
270-8681	H55D/H65D PIN-ON, LINES, 3-4 TON MINI EXCAVATOR Includes hose assemblies, quick disconnects and connectors. For use on skid steer loaders with BH150 or BH160 and pin-on H55E/H65E.
316-0411	H55D MOUNTING GROUP, 40 MM (1.6 IN) Includes two bucket pins, four retention pins and four bushings. For use on skid steer loaders with BH160 and pin-on H55D.
252-1211	H65D MOUNTING GROUP, 40 MM (1.6 IN) Includes two bucket pins, four retention pins and four bushings. For use on skid steer loaders with BH160 and pin-on H65D.



Material Handling Arm

is useful in industrial, construction and agricultural applications to pick-up, carry and load a variety of materials and equipment.



Material Handling Arm

MATERIAL HANDLING ARM

Overall Height	mm (in)	1473 (58)
Overall Width	mm (in)	1316 (52)
Retracted Length	mm (in)	1016 (40)
Max Horizontal Reach	mm (in)	2134 (84)
Max Load Rating	kg (lb)	907 (2000)
Weight	kg (lb)	127 (280)
Part Number		216-8756

SKID STEER LOADERS AND COMPACT TRACK LOADERS ATTACHMENTS

Mulchers are designed for high-performance cutting and mulching vegetation and undergrowth. They reduce saplings, shrubs and trees into mulched material, making them ideal for environmental maintenance, such as creating fire lanes. Other applications include land reclamation, foliage removal from building construction sites, and shredding pruned material and organic waste for biomass production. The bite limiter minimizes stalling of the mulcher and the chisel blade is designed to increase life and serviceability.



MULCHERS							
MODEL		HM112	HM115	HM215	HM316	HM416	HM418
Overall Width	mm (in)	1518 (60)	1758 (69)	1758 (69)	1882 (74)	1882 (74)	2122 (84)
Working Width	mm (in)	1240 (49)	1480 (58)	1480 (58)	1582 (62)	1488 (59)	1707 (67)
Overall Height	mm (in)	1281 (50)	1281 (50)	1281 (50)	1481 (58)	1481 (58)	1481 (58)
Weight	kg (lb)	763 (1682)	818 (1803)	818 (1803)	1342 (2959)	1343 (2961)	1450 (3197)
Required Hydraulics		STD Flow	STD Flow	HF	HF XPS	XHP/XE	XHP/XE
Part Number		475-2750*	475-2760*	475-2770**	475-2780**	475-2790***	475-2800***

*Requires 377-1579 conversion harness for B/B2/C/C2 series high flow machines plus Turbo Guard Kit and Debris Kit on machine.

**Requires 371-3725 conversion harness for B/B2/C/C2 series high flow machines plus Turbo Guard Kit and Debris Kit on machine.

***Requires Conversion to screw-to-connect quick disconnects for 299D2 XHP, serial prefix HLM (see M0097141) and 299D3 XE, serial prefix XES/LB3 (see M0110695), plus Turbo Guard Kit and Debris Kit on machine.

MULCHERS – BITE LIMITER				
MODEL		HM316	HM416	HM418
Overall Width	mm (in)	1882 (74)	1882 (74)	2122 (84)
Working Width	mm (in)	1582 (62)	1582 (62)	1822 (72)
Overall Height	mm (in)	1480 (58)	1480 (58)	1480 (58)
Weight	kg (lb)	1385 (3053)	1370 (3020)	1504 (3316)
Required Hydraulics		HF XPS	XHP/XE	XHP/XE
Part Number		551-4680	551-4690	551-4700



MULCHER OPTIONS	
Part Number	Description
231-2578	MANUAL COUPLER GUARD Two required per machine to shield manual levers from debris or damage. Not compatible with D series.

SKID STEER LOADERS AND COMPACT TRACK LOADERS ATTACHMENTS

MULCHER TEETH*

Part Number	Description	Model (Quantity)
475-2746	Reversible Chisel Tooth	HM112 (30), HM115 (36), HM215 (36)
504-6100	Carbide Tipped Chisel Tooth	HM112 (30), HM115 (36), HM215 (36)
475-2747	Tooth Kit (pack of 10× 475-2746)	
482-1444	Single Retention Bolt	HM112 (30), HM115 (36), HM215 (36)
475-2810	Standard Carbide Tooth	HM316 (32), HM416 (32), HM418 (38)
475-2811	Right Side Scraper Carbide	HM316 (1), HM416 (1), HM418 (1)
475-2812	Left Side Scraper Carbide	HM316 (1), HM416 (1), HM418 (1)
475-2819	Tooth Kit (pack of 10× 475-2810)	
475-2816	Bolt Kit S/N MH500146 and below	HM316 (34), HM416 (34), HM418 (38)
487-2141	Bolt Kit S/N MH500147 and up	HM316 (34), HM416 (34), HM418 (38)

*Replacement teeth available through Parts/Antares only.

SKID STEER LOADERS AND COMPACT TRACK LOADERS ATTACHMENTS

INDUSTRIAL GRAPPLE RAKES

Width	mm (in)	1829 (72)	2134 (84)
Length	mm (in)	1016 (40)	1016 (40)
Height	mm (in)	838 (33)	838 (33)
Jaw Opening	mm (in)	940 (37)	940 (37)
Weight	kg (lb)	485 (1070)	506 (1115)
Required Hydraulics		STD Flow	STD Flow
Part Number		286-9300	286-9301



Industrial Grapple Rakes

Landscape Rakes use the scarifying action of the hardened teeth to pulverize, aerate, level and condition the soil while collecting and depositing rock and debris in the integrated hopper.



Landscape Rake

LANDSCAPE RAKES

MODEL		LR116	LR119
Working Width	mm (in)	1576 (62)	1883 (74)
Raking Width	mm (in)	1384 (55)	1665 (66)
Overall Width	mm (in)	1683 (66)	1990 (78)
Height	mm (in)	989 (39)	989 (39)
Length	mm (in)	1620 (64)	1620 (64)
Weight	kg (lb)	595 (1312)	653 (1440)
Required Hydraulics		STD Flow	STD Flow
Part Number		224-9220	224-9221

Power Box Rakes

are ideal for clearing and preparing soil, offering the versatility to de-thatch, remove old lawns and weeds, grade, level, rake, remove debris and prepare seedbeds all with one work tool.



Power Box Rake



POWER BOX RAKES

MODEL		PR118	PR118	PR121	PR121	PR123
Angle Control		Manual	Hydraulic	Manual	Hydraulic	Hydraulic
Overall Width	mm (in)	2057 (81)	2057 (81)	2362 (93)	2362 (93)	2515 (99)
Raking Width at Max Angle	mm (in)	1727 (68)	1727 (68)	2007 (79)	2007 (79)	2159 (85)
Overall Height	mm (in)	847 (33)	847 (33)	847 (33)	847 (33)	953 (38)
Weight	kg (lb)	408 (900)	427 (941)	465 (1025)	483 (1065)	606 (1336)
Required Hydraulics		STD Flow	STD Flow	STD Flow	STD Flow	STD Flow
Part Number		608-0655	608-0650	608-0665	608-0660	608-0670

SKID STEER LOADERS AND COMPACT TRACK LOADERS ATTACHMENTS

SCRAP SHEAR

MODEL		S308
Height	mm (in)	667 (26)
Width	mm (in)	390 (15)
Length	mm (in)	1709 (67)
Jaw Opening	mm (in)	240 (9)
Required Hydraulics		STD Flow
Weight	kg (lb)	550 (1213)
Part Number		583-8100*

*Requires 441-6167 control kit and 583-8150 bracket.

Cat Shears rotate 360 degrees for rapid repositioning and are designed with a straight lower jaw to improve cutting force.



Scrap/Demolition Shear

Skid Steer Loader
Bracket



KIT/BRACKET (REQUIRED)

Part Number	Description
441-6167	S308 SKID STEER LOADER CONTROL KIT Allows switching between 360 degrees rotation and opening/closing of shear. Includes hydraulic lines with quick disconnects, hydraulic valve for opening/closing and rotation of shear, and 14-pin harness to operate hydraulic valve.
583-8150	S308 SKID STEER LOADER BRACKET Allows use of S308 shear on a skid steer quick coupler.

SKID STEER LOADERS AND COMPACT TRACK LOADERS ATTACHMENTS



Silage Defacer



Stump Grinder

Silage Defacers high tensile strength teeth pull and separate silage or haylage predictably and repeatedly while optimizing operator visibility and reach.

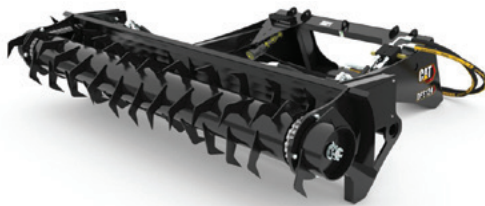

Silage Defacers



Stump Grinders

offer the right balance of cutting wheel speed and torque to make quick work of most tree varieties.



Stump Grinders



SILAGE DEFACERS

MODEL	DFS118	DFS121	DFS124
Overall Width mm (in)	1841 (73)	2146 (85)	2451 (97)
Overall Height mm (in)	639 (25)	639 (25)	639 (25)
Weight kg (lb)	425 (937)	477 (1052)	503 (1109)
Required Hydraulics	STD Flow	STD Flow	STD Flow
Part Number	477-9900	479-8090	479-8110

STUMP GRINDERS

MODEL	SG16	SG36
Cutting Depth (below ground) mm (in)	521 (21)	521 (21)
Cutting Height (above ground) mm (in)	470 (19)	470 (19)
Overall Height mm (in)	730 (29)	813 (32)
Overall Length mm (in)	1737 (68)	1737 (68)
Overall Width mm (in)	1175 (46)	1175 (46)
Weight kg (lb)	379 (836)	400 (882)
Required Hydraulics	STD Flow	HF/HF XPS
Part Number	424-0461	424-0460

SKID STEER LOADERS AND COMPACT TRACK LOADERS ATTACHMENTS

Snow Blowers are designed for removing snow from streets, parking lots, driveways and sidewalks, making them ideal for various winter cleanup and maintenance applications.



Snow Blowers

SNOW BLOWERS

MODEL		SR115	SR118	SR121	SR318	SR321	SR418	SR421
Intake Width	mm (in)	1290 (51)	1614 (64)	1942 (77)	1614 (64)	1942 (77)	1614 (64)	1942 (77)
Cutting Height	mm (in)	867 (34)	867 (34)	867 (34)	867 (34)	867 (34)	867 (34)	867 (34)
Maximum Throw	m (ft)	12 (40)	12 (40)	12 (40)	12 (40)	12 (40)	12 (40)	12 (40)
Optimal Hydraulic Pressure	bar (psi)	230 (3336)	230 (3336)	230 (3336)	280 (4061)	280 (4061)	280 (4061)	280 (4061)
Overall Width	mm (in)	1572 (62)	1877 (74)	2181 (86)	1877 (74)	2181 (86)	1877 (74)	2181 (86)
Overall Height	mm (in)	1843 (73)	1843 (73)	1843 (73)	1843 (73)	1843 (73)	1843 (73)	1843 (73)
Overall Length	mm (in)	951 (37)	951 (37)	951 (37)	951 (37)	951 (37)	951 (37)	951 (37)
Weight	kg (lb)	463 (1021)	478 (1054)	501 (1105)	495 (1091)	518 (1142)	512 (1129)	535 (1180)
Required Hydraulics		STD Flow	STD Flow	STD Flow	HF XPS	HF XPS	XHP/XE	XHP/XE
Part Number		580-0607*	546-4485*	545-8977*	546-4509*	546-4504*	585-5465	585-5467

*Requires Work Tool harness and four button left hand joystick to operate chute rotation and chute angle.



Snow Performance Kit

SNOW PERFORMANCE KIT

Part Number	Description
546-4522	Includes two side cutters, one partial impeller/fan cover, one chute frontplate, one chute non metallic liner and fixing materials.

SKID STEER LOADERS AND COMPACT TRACK LOADERS ATTACHMENTS

Snow Plows employ a robust design for moving snow with maximum efficiency and power.



Snow Plows



SNOW PLOWS

MODEL		1.8 m (6 ft)	2.1 m (7 ft)	2.4 m (8 ft)	2.7 m (9 ft)	3 m (10 ft)
Width	mm (in)	1826 (72)	2134 (84)	2435 (96)	2743 (108)	3045 (120)
Overall Height	mm (in)	800 (32)	800 (32)	800 (32)	800 (32)	800 (32)
Blade Height	mm (in)	797 (31)	797 (31)	797 (31)	797 (31)	797 (31)
Length	mm (in)	1247 (49)	1247 (49)	1247 (49)	1247 (49)	1247 (49)
Weight	kg (lb)	450 (992)	477 (1052)	502 (1107)	527 (1162)	552 (1217)
Required Hydraulics		STD Flow	STD Flow	STD Flow	STD Flow	STD Flow
Part Number		481-3666	481-3667	481-3668	481-3669	481-3670

SKID STEER LOADERS AND COMPACT TRACK LOADERS ATTACHMENTS

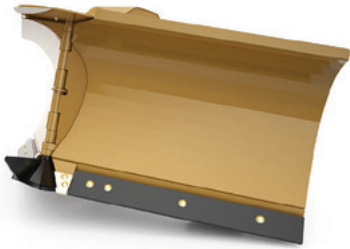

Multi V-Plows

MULTI V-PLOWS

MODEL		1.5 m (5 ft)	2.1 m (7 ft)
Straight Width	mm (in)	1524 (60)	2134 (84)
Length	mm (in)	1320 (52)	1320 (52)
Overall Height	mm (in)	826 (33)	826 (33)
Weight	kg (lb)	290 (639)	426 (939)
Required Hydraulics		STD Flow	STD Flow
Part Number		542-7309	542-7310



Snow Wings

SNOW WINGS

MODEL		2.4 m (8 ft)	2.8 m (9 ft)
Working Width – Wings Open	mm (in)	4106 (162)	4411 (174)
Working Width – Wings Closed	mm (in)	2451 (97)	2756 (109)
Overall Height	mm (in)	915 (36)	915 (36)
Length	mm (in)	1705 (67)	1705 (67)
Weight	kg (lb)	867 (1911)	885 (1951)
Wing Rotation		180°	180°
Angling – Left/Right of Center		35°	35°
Required Hydraulics		STD Flow	STD Flow
Part Number		608-7779*	608-7780*

*Requires Work Tool Harness and Deluxe LH Joystick with four buttons.



SKID STEER LOADERS AND COMPACT TRACK LOADERS ATTACHMENTS

Straight Snow Pushes are designed to roll and fold snow with a profiled mold board, maximizing the amount of snow being pushed. Streamlined box supports ensure that snow does not cling and a standard trip edge system protects from unseen obstacles.



Straight Snow Push

SNOW PUSHES

MODEL		2.44 m (8 ft)	2.44 m (8 ft)	2.44 m (8 ft)	3.05 m (10 ft)	3.05 m (10 ft)
Working Width	mm (in)	2438 (96)	2438 (96)	2438 (96)	3048 (120)	3048 (120)
Overall Width	mm (in)	2553 (101)	2553 (101)	2553 (101)	3162 (124)	3162 (124)
Trip Edge Height	mm (in)	—	119 (4.7)	119 (4.7)	—	119 (4.7)
Overall Height	mm (in)	914 (36)	994 (39)	994 (39)	914 (36)	994 (39)
Length	mm (in)	1109 (44)	1143 (45)	1143 (45)	1109 (44)	1143 (45)
Weight	kg (lb)	353 (778)	470 (1036)	491 (1083)	393 (866)	523 (1153)
Trip Edge Type		Rubber	Rubber	Steel	Rubber	Rubber
Cutting Edge		—	489-3913	489-3921	—	482-1496
Trip Edge		No	Yes	Yes	No	Yes
Part Number		509-3705	479-8115	479-8120	509-3706	479-8086

SNOW PUSHES (CONTINUED)

MODEL		3.05 m (10 ft)	3.66 m (12 ft)	3.66 m (12 ft)	3.66 m (12 ft)
Working Width	mm (in)	3048 (120)	3658 (144)	3658 (144)	3658 (144)
Overall Width	mm (in)	3162 (124)	3772 (149)	3772 (149)	3772 (149)
Trip Edge Height	mm (in)	119 (4.7)	—	119 (4.7)	119 (4.7)
Overall Height	mm (in)	994 (39)	914 (36)	994 (39)	994 (39)
Length	mm (in)	1143 (45)	1109 (44)	1143 (45)	1143 (45)
Weight	kg (lb)	545 (1202)	432 (952)	611 (1347)	636 (1402)
Trip Edge Type		Steel	Rubber	Rubber	Steel
Cutting Edge		482-7668	—	489-3929	489-3927
Trip Edge		Yes	No	Yes	Yes
Part Number		479-8096	509-3707	479-8089	479-8099

SKID STEER LOADERS AND COMPACT TRACK LOADERS ATTACHMENTS

SNOW PUSH BACK DRAG EDGES

MODEL	2.5 m (8 ft)	3.1 m (10 ft)	3.7 m (12 ft)
Steel Edge	481-3680	481-3686	481-3689
Rubber Edge	481-3675	481-3676	481-3679

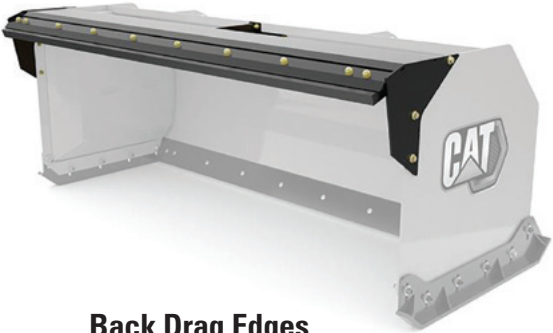

Back Drag Edges

SKID STEER LOADERS AND COMPACT TRACK LOADERS ATTACHMENTS



Landscape Tillers are designed to break up and pulverize soil, mix compost or other materials into existing soil, and stabilize and level existing terrain in landscape finish applications.



Landscape Tiller

LANDSCAPE TILLERS			
MODEL		LT114	LT118
Working Width	mm (in)	1354 (53)	1848 (73)
Working Depth	mm (in)	152 (6)	152 (6)
Overall Width	mm (in)	1789 (70)	2272 (89)
Length	mm (in)	956 (38)	956 (38)
Height	mm (in)	755 (30)	755 (30)
Weight	kg (lb)	340 (750)	420 (926)
Required Hydraulics		STD Flow	STD Flow
Part Number		219-7165	219-0426

SKID STEER LOADERS AND COMPACT TRACK LOADERS ATTACHMENTS

Trenchers are used for cutting narrow straight trenches in soil prior to laying electrical, telephone and cable lines, as well as water and gas pipe.



TRENCHERS				
MODEL		T109	T109	T109
Side Shift Control		Manual	Hydraulic	Manual
Cutting Width	mm (in)	152 (6)	152 (6)	203 (8)
Overall Width	mm (in)	1426 (56)	1426 (56)	1426 (56)
Overall Length	mm (in)	2348 (92)	2348 (92)	2348 (92)
Overall Height	mm (in)	786 (31)	786 (31)	786 (31)
Side Shift Travel	mm (in)	419 (17)	419 (17)	419 (17)
Standard Boom Length	mm (in)	914 (36)	914 (36)	914 (36)
Weight*	kg (lb)	459 (1012)	488 (1076)	466 (1028)
Required Hydraulics		STD Flow	STD Flow	STD Flow
With Chain				
Standard*		261-4806	261-4859	261-8557
Combo		261-8559	261-8560	—
Rockfrost		261-8561	261-8562	—
Terminator		261-8563	261-8564	—

*Weight with Standard Chain

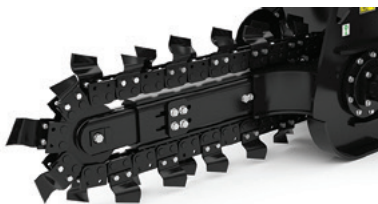

Standard



Combo

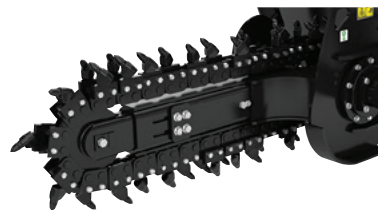

Rockfrost



Terminator

SKID STEER LOADERS AND COMPACT TRACK LOADERS

ATTACHMENTS

TRENCHERS (CONTINUED)

MODEL		T109	T112	T112	T112	T315	T315
Side Shift Control		Hydraulic	Manual	Hydraulic	Hydraulic	Hydraulic	Hydraulic
Cutting Width	mm (in)	203 (8)	152 (6)	152 (6)	203 (8)	152 (6)	203 (8)
Overall Width	mm (in)	1426 (56)	1901 (75)	1901 (75)	1901 (75)	1901 (75)	1901 (75)
Overall Length	mm (in)	2348 (92)	2705 (107)	2705 (107)	2705 (107)	3010 (119)	3010 (119)
Overall Height	mm (in)	786 (31)	786 (31)	786 (31)	786 (31)	786 (31)	786 (31)
Side Shift Travel	mm (in)	419 (17)	559 (22)	559 (22)	559 (22)	559 (22)	559 (22)
Standard Boom Length	mm (in)	914 (36)	1219 (48)	1219 (48)	1219 (48)	1524 (60)	1524 (60)
Weight*	kg (lb)	495 (1092)	488 (1076)	509 (1121)	538 (1186)	550 (1212)	584 (1287)
Required Hydraulics		STD Flow	STD Flow	STD Flow	STD Flow	HF XPS	HF XPS
With Chain							
Standard*		261-8558	233-2346	241-4252	241-4253	424-0471	424-0472
Combo		—	233-2350	241-4254	—	424-0473	—
Rockfrost		—	241-4251	241-4255	—	—	—
Terminator		—	—	—	—	—	—

*Weight with Standard Chain

TRENCHER CHAINS ONLY

MODEL	T109	T109	T109	T109	T112	T112
	152 mm (6 in)	203 mm (8 in)	254 mm (10 in)	305 mm (12 in)	152 mm (6 in)	203 mm (8 in)
Standard	259-0312	258-8644	263-3431	263-3430	189-5956	222-7916
Combo	261-4860	—	—	—	222-7742	—
Rockfrost	261-4805	—	—	—	222-7743	—
Terminator	243-6349	—	—	—	262-7624	—
Combo Carbide	—	—	—	—	—	208-2694
Combo Conical	—	—	—	—	208-2690	208-2693

TRENCHER CHAINS ONLY (CONTINUED)

MODEL	T112	T315	T315	T315
	254 mm (10 in)	152 mm (6 in)	203 mm (8 in)	254 mm (10 in)
Standard	208-2678	189-5957	222-8523	208-2679
Combo	—	222-7747	—	—
Rockfrost	—	208-2697	—	—
Terminator	—	262-7623	—	—
Combo Carbide	—	—	208-2699	—
Combo Conical	—	208-2695	208-2698	—

Optional Crumber Arm and Shoe

ensures smooth trench bottom following chain teeth and consistent placement of excavated dirt.

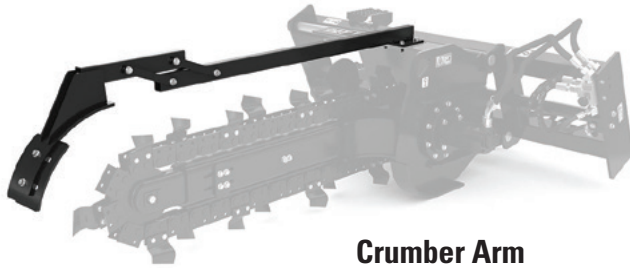

Crumber Arm

TRENCH CRUMBER ARMS

MODEL	T109	T112	T315
Part number	264-5714	264-7601	264-7602

CRUMBER ARM SHOES

Shoe	152 mm/202 mm (6 in/8 in)	254 mm/305 mm (10 in/12 in)
Part number	264-7597	264-7598

SKID STEER LOADERS AND COMPACT TRACK LOADERS ATTACHMENTS

WHEEL SAWS

MODEL	SW345-80	SW345-130	SW360-80	SW360-100	SW360-130	SW360-160	SW360-200
Overall Width mm (in)	1655 (65)	1655 (65)	1655 (65)	1655 (65)	1655 (65)	1655 (65)	1655 (65)
Wheel Width mm (in)	80 (3)	130 (5)	80 (3)	100 (4)	130 (5)	160 (6)	200 (8)
Overall Height mm (in)	1455 (57)	1455 (57)	1765 (69)	1765 (69)	1765 (69)	1765 (69)	1765 (69)
Length mm (in)	2165 (85)	2165 (85)	2417 (95)	2417 (95)	2417 (95)	2417 (95)	2417 (95)
Weight kg (lb)	1126 (2482)	1016 (2240)	1440 (3175)	1335 (2943)	1365 (3009)	1315 (2899)	1325 (2921)
Max Cutting Depth mm (in)	450 (18)	450 (18)	600 (24)	600 (24)	600 (24)	600 (24)	600 (24)
Required Hydraulics	HF XPS	HF XPS	HF XPS	HF XPS	HF XPS	HF XPS	HF XPS
Trench Cleaning Device	No	Yes	No	Yes	Yes	Yes	Yes
Part Number	529-5880	529-5867	529-5860	529-5868	529-5869	529-5861	529-5862

WHEEL SAWS (CONTINUED)

MODEL	SW380	SW460-80	SW460-160	SW460-200	SW480
Overall Width mm (in)	1655 (65)	1655 (65)	1655 (65)	1655 (65)	1655 (65)
Wheel Width mm (in)	250 (10)	80 (3)	160 (6)	200 (8)	250 (10)
Overall Height mm (in)	1860 (73)	1765 (69)	1765 (69)	1765 (69)	1860 (73)
Length mm (in)	2600 (102)	2417 (95)	2417 (95)	2417 (95)	2600 (102)
Weight kg (lb)	1450 (3197)	1440 (3175)	1315 (2899)	1325 (2921)	1450 (3197)
Max Cutting Depth mm (in)	800 (32)	600 (24)	600 (24)	600 (24)	800 (32)
Required Hydraulics	HF XPS	XHP/XE	XHP/XE	XHP/XE	XHP/XE
Trench Cleaning Device	No	No	Yes	Yes	No
Part Number	529-5890	529-5863	529-5864	529-5865	529-5891



Wheel Saw

WHEEL SAW WATER SPRAY KITS

Part Number	Description
591-0708	SW345/360 WATER SPRAY KIT Includes four sprinkler heads, hoses, one quick disconnect for water and mounting hardware. Requires cab mounted water tank.
591-0709	SW380/480 WATER SPRAY KIT Includes four sprinkler heads, hoses, one quick disconnect for water and mounting hardware. Requires cab mounted water tank.

WHEEL SAW BITS*

Part Number	Description
222-7571	All Purpose bit
227-7340	Concrete bit
375-7681	Heavy Duty Concrete bit
316-2326	Heavy Duty Asphalt bit
226-9308	Block Holder for bit
104-8591	Punch (bit remover)
8T-4474	Puller (bit remover)

*An inventory holding of at least 100 of each tip is advised.

SKID STEER LOADERS AND COMPACT TRACK LOADERS ATTACHMENTS

CONVERSION KITS

Part Number	Description
379-0420	COLD PLANER and WHEEL SAW CONVERSION KIT This kit converts cold planers and wheel saws that use a 5- line configuration to support both 3 and 5 lines.
382-6180	MULCHER CONVERSION KIT – 3 LINES This kit will reconfigure older HM312 and HM315 mulchers that are only equipped with a 5-line/8-pin connection to also support a 3-line/14-pin connection.
382-6170	SG18B STUMP GRINDER CONVERSION KIT – 3 LINES This kit will reconfigure SG18B high flow stump grinders that are currently equipped with the 5-line/8-pin connection to allow for operation on skid steer loaders that are equipped with 3-line/14-pin connection.
375-6445*	CONVERSION HARNESS, 8-PIN TO 14-PIN This harness will adapt Cat attachments that have an 8-pin electrical harness to a Cat machine that has a 14-pin work tool harness.
377-1579	CONVERSION HARNESS, 14-PIN TO 8-PIN This harness will adapt Cat attachments that have a 14-pin electrical harness to a Cat machine that has an 8-pin work tool harness.
371-3725	CONVERSION KIT – WORK TOOL CONVERSION TO 5-LINES This kit converts new cold planers and wheel saws equipped with a 3-line/14-pin connection to a 5-line and/or 8-pin electrical harness. For use with older machines.
509-2817**	CONVERSION HARNESS - 1-5 FUNCTION TO 14-PIN This harness adapts Cat attachments to non-Cat machines that use a 14-pin electrical connector. The harness will plug into the machine side 14-pin connector and has loose wires on the opposite end that can be configured to suit the attachments being used.
520-3445	CONVERSION HARNESS – 2 PIN DELPHI This harness converts Delphi style electrical connectors used on competitive attachments to Deutsch style electrical connectors used on Cat harnesses.

*Note: 377-5466 14-pin HF XPS electrical jumper plug available through parts only.

**Requires 344-6145 Receptacle (14-pin male harness, not included).

DEMO CONTROL KIT

Part Number	Description
296-0582	DEMO CONTROL HARNESS KIT Enables Cat dealers to demonstrate an electronically controlled work tool quickly and easily on B/B2/B3 standard flow/C/C2 machines that are not equipped with Control-Work Tool Electrical.
423-8296	DEMO CONTROL HARNESS KIT Enables Cat dealers to demonstrate an electronically controlled work tool quickly and easily on B3 high flow and D series machines that are not equipped with Control-Work Tool Electrical.



AEXQ3015-01 (03-2022)
Replaces AEXQ3015-00
(Global)

